

KOBELCO

SK225SR-7/SK230SRLC-7/SK235SR-7/SK270SRLC-7

Performance  Design

SK225SR
SK230SR^{LC}
SK235SR
SK270SR^{LC}

■ Bucket capacity:

0.51 – 0.93 m³

■ Engine power:

127 kW / 2,000 min⁻¹

■ Operating weight:

23,500 – 28,200 kg



We Save You Fuel
Achieving a Low-Carbon Society



SK235SR



Performance Design

With the release of the SK225SR/SK230SRLC/SK235SR/SK270SRLC, KOBELCO has completely harmonised the values of PERFORMANCE and DESIGN. The SK225SR/SK230SRLC/SK235SR/SK270SRLC delivers greater efficiency and productivity with increased power and speed, along with uncompromising operator comfort and machine operability. In the pursuit of producing unique and unbeatable machines that provide comfort and productivity without equal, KOBELCO continues to rise to the challenge.

THE ULTIMATE SLEEK AND STYLISH CAB DESIGN

True ergonomic functionality combined with modern design has resulted in a cabin interior that is sleek and comfortable, built for simplicity and operator comfort.

Jog dial

The jog dial integrates multiple functions to allow for simple navigation of machine information screens, even while wearing gloves.

LED backlights

LED backlighting on switches and dials provides a bright, clear view of controls, even in the dark, while delivering a premium look and feel.







UNFORGETTABLE COMFORT

Air suspension seat

A GRAMMER* seat is installed as standard equipment, which achieves excellent shock absorption and superior ride comfort.

*GRAMMER is trademark of GRAMMER AG, registered in Germany and other countries.

Optimal air conditioning vent placement

Air conditioning vents are optimally placed around the cabin with air flow directed toward the operator's neck and back, providing more comfortable operation.

Ergonomic and low-effort pilot control levers

Pilot control levers are mounted on adjustable consoles, with an ergonomic design that allows movement without twisting, reducing operator fatigue.



New Hydraulic Control

Our newly upgraded hydraulic control system responds to shorter lever strokes than current models, delivering swifter, more precise movement and improved lever operability.

LED door light

The LED interior light automatically turns on when the door is opened or when the ignition is set to OFF. This ensures easy entry and exit at nighttime.



KOBELCO



04:33



SETTING MENU



PICTURE OF CAMERA



CLOCK SETTING



SCREEN BRIGHTNESS



MAINTENANCE



CONSUMPTION



LANGUAGE SELECTION



PRESSURE RELEASE



A WIDER VIEW BRINGS A WIDER RANGE OF USE

10-inch colour monitor—the largest in the industry

The easy-to-operate menu screen facilitates easy reading and navigation. Images from the built-in cameras can be checked on the large screen, which helps to improve safety. In addition, each icon is easily recognisable.

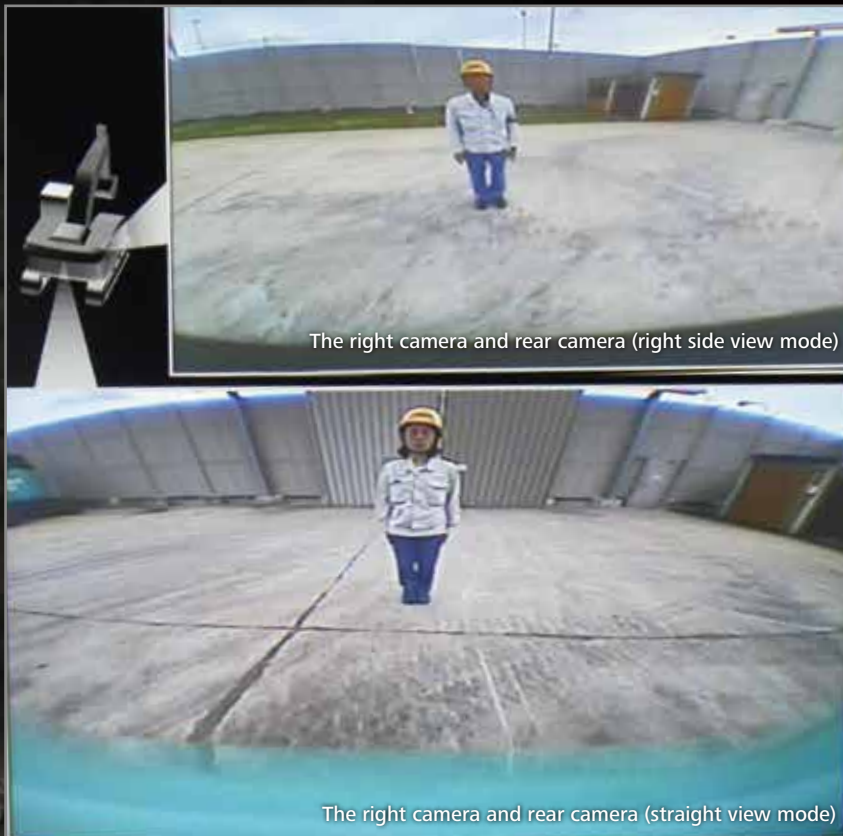

The right camera and rear camera (right side view mode)

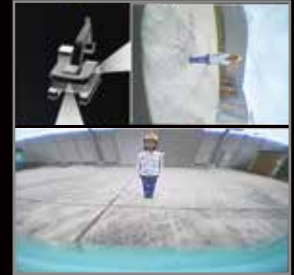

The right camera and rear camera (straight view mode)



SAFETY ON FULL DISPLAY

Our high-resolution, large display shows right, left and rear side cameras together. Multiple camera modes allow operators to customise their display based on their needs to enhance awareness and jobsite safety.

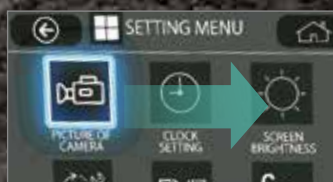

Screen display linked with the jog dial operation

The jog dial provides simple and intuitive control of all display screens. Turn the jog dial to the right or left to select an item and press the dial to confirm the selection.

IDEAL FOR URBAN WORK SITES WITH A WIDE WORKING RANGE

Minimal swing radius improves efficiency

The tail of the upper body extends very little past the crawlers, so the operator can concentrate on the job at hand. This also reduces the risk of collision damage.

Easy workability even in Close Quarters

The compact design allows continuous 180° dig, and load operations within a working space of just 4.06m (SK225SR/SK230SRLC) / 3.68m (SK235SR/SK270SRLC).



Figures above show the value for standard boom and standard arm spec.
* For SK225SR/SK230SRLC
** For SK235SR/SK270SRLC

THE NEXT LEVEL OF PERFORMANCE

Higher Efficiency, plus a Tier IV Final Compliant Engine

The new SK225SR/SK230SRLC/SK235SR/SK270SRLC, is equipped with a Yanmar Tier IV Final Compliant engine, which has a higher torque value. Superior balance between engine output and torque contributes to more efficient performance than the previous models. In addition, the DPF replacement interval has been extended.

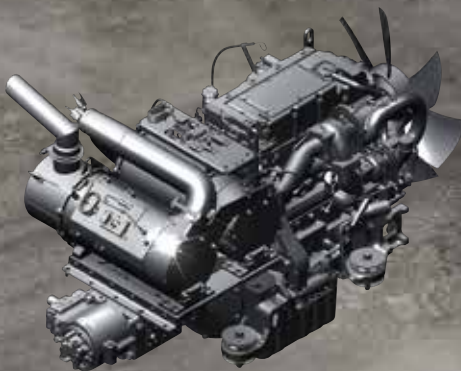

Model: YANMAR 4TN107FTT

Engine output

127 kW/2,000 min⁻¹

Independent Travel

Selecting Independent Travel dedicates one hydraulic pump to travel and one to the attachment on a continuous basis, allowing for a smooth and constant movement speed even while swinging or using the boom or attachment. With Independent Travel, safely carrying a large pipe across a job site is a breeze.

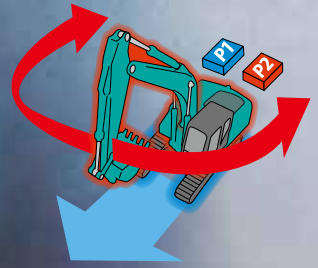

GREATER MULTI-FUNCTION CAPABILITIES

Attachment mode

The flow-rate modes of the bucket, breaker, nibbler, and rotating grapple are set before delivery, which allows you to start operating immediately.

Mode settings for other attachments, such as the tilt rotator, can easily be added or changed.



CONVENIENT AND SENSIBLE EQUIPMENT



Rear camera



Right camera

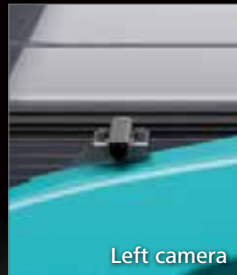

Left camera

Standard Rear, Left and Right Side Cameras



Seatbelt Unfastened Indicator On Monitor



Arm



Boom



Bucket link



Counterweight

Machine Guidance Ready Brackets

Pre-welded brackets for quicker and easier installation of Machine Guidance Systems.



Console mount

The console-integrated seat allows for comfortable operation.



AM/FM Bluetooth® (hands-free) radio

Audio streaming and hands free phone calling capability.



USB port/12 V power outlet



Smartphone holder

You can use the holder with your smartphone connected to the USB port.



Engine start password

A password is required when starting the engine for greater security.



Wiper adjustment function

In addition to the intermittent wiper mode and continuous wiper mode, the one-time wiper mode was added.

Excavator Remote Monitoring System



Remote Monitoring for Peace of Mind

GEOSCAN uses satellite communication and internet to relay data, and therefore can be deployed in areas where other forms of communication are difficult. When a hydraulic excavator is fitted with this system, data on the machine's operation, such as operating hours, location, fuel consumption, and maintenance status can be obtained remotely.

Direct Access to Operational Status

Location Data

• Accurate location data can be obtained even from sites where communications are difficult.

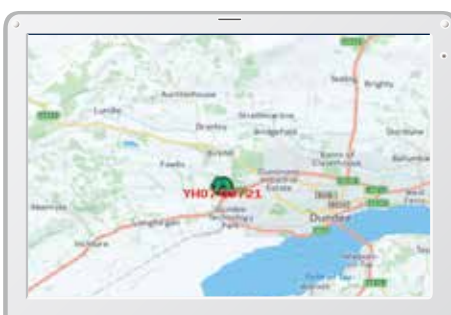

Work data

Type of Operation	Working Hrs	Ratio
Total Working Hrs	169 Hrs	100 %
Digging Hrs	72.2 Hrs	43 %
Traveling Hrs	18.3 Hrs	11 %
Idle Hrs	15.9 Hrs	9 %
Opt Att Hrs	62.5 Hrs	37 %
Crane Mode Hrs	0 Hrs	0 %

Operating Hours

- A comparison of operating times of machines at multiple locations shows which locations are busier and more profitable.
- Operating hours on site can be accurately recorded, for running time calculations needed for rental machines, etc.

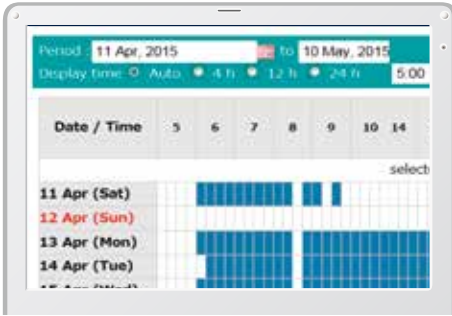

Daily report

Fuel Consumption Data

- Data on fuel consumption and idling times can be used to indicate improvements in fuel consumption.

Work mode	Working Hrs	Total Fuel Consumption
H mode	2:06	24.5 L
S mode	0:00	0.0 L
E mode	169:19	1489.7 L
TOTAL	171:25	1514.2 L

Fuel consumption

Graph of Work Content

- The graph shows how working hours are divided among different operating categories, including digging, idling, travelling and optional operations.



Work status

Maintenance Data and Warning Alerts

Machine Maintenance Data

- Provides maintenance status of separate machines operating at multiple sites.
- Maintenance data is also relayed to KOBELCO service personnel, for more efficient planning of periodic servicing.

Model	Serial No.	Hour Meter	Engine Oil
SK135RSLC-3/SK140SRL	YH07-09721	734 Hr	434
SK135RSLC-3/SK140SRL	YH07-09789	73 Hr	429
SK210LC-9	YQ13-10454	960 Hr	58
SK210LC-9	YQ13-10481	549 Hr	498
SK75SR-	YT08-30374		

Maintenance

Warning Alerts

- This system gives an alert if an anomaly is sensed, preventing damage that could result in machine downtime.

Alarm Information Can Be Received via E-mail

- Alarm information or maintenance notice can be received via e-mail, using a computer or a mobile device.



Alarm messages can be received on a mobile device.

Daily/Monthly Reports

- Operational data downloaded onto a computer helps in formulating daily and monthly reports.

Security System

Engine Start Alarm

- The system can be set up with an alarm if the machine is operated outside designated time.

Engine start alarm outside prescribed work time

Area Alarm

- It can be set up with an alarm if the machine is moved out of its designated area to another location.

Alarm for outside of reset area

NON-STOP OPERATION BY iNDr

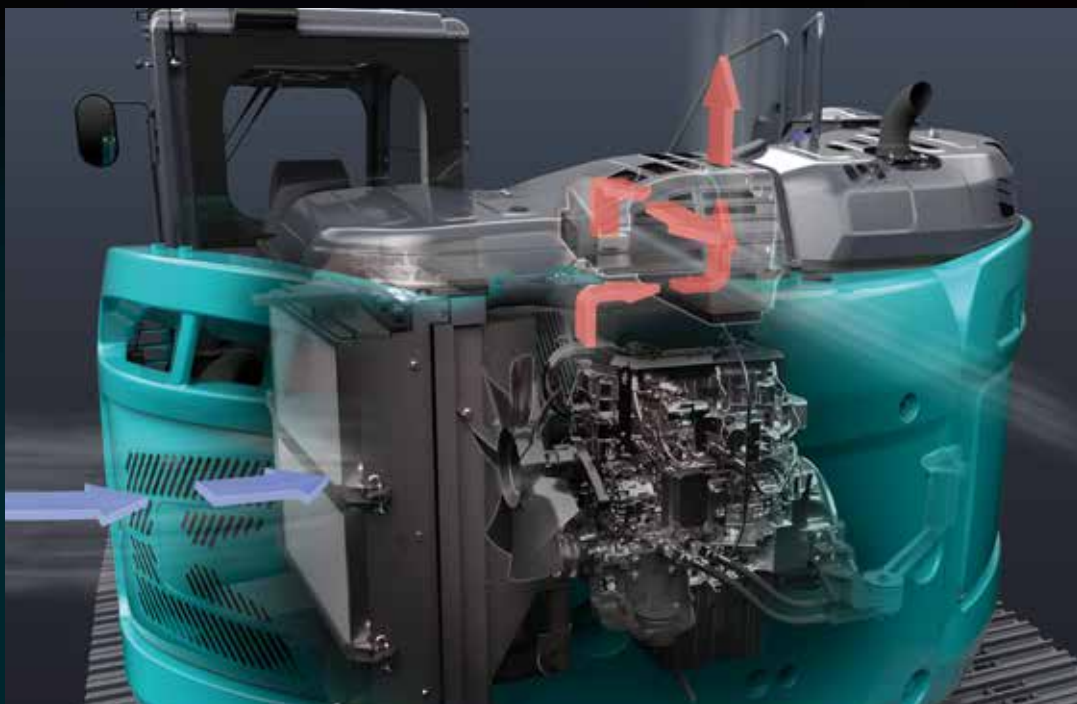

Ultimate low noise

KOBELCO's exclusive iNDr Cooling System delivers amazingly quiet operation.

iNDr Filter

A high-density mesh filter blocks dust intruding during air intake. This prevents the cooling device and the air cleaner from clogging with dust and maintains their performances. The ridges of the corrugated filter allow the air to pass through, and the grooves collect the dust, which prevents the filter from clogging.

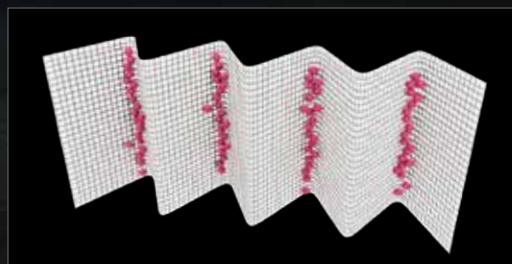

The iNDr filter has a high-density mesh of 30 lines per inch to collect dust.

EASY MAINTENANCE



Standard Overhead Top Guard Level II

The standard overhead cab guard can be tilted open with gas damper for easy window cleaning. Meets standard top guard level II requirements. (ISO 10262)



Two-Stage Air Filter



Left Side (Radiator and Cooling System Elements)

Laid out for easy access to radiator and cooling system with clean out screen.



DEF/AdBlue® Tank

The DEF/AdBlue® fill is placed on the step for easy access.

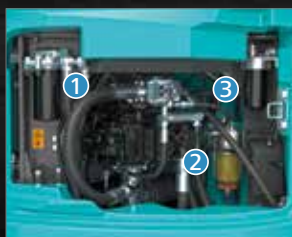

Right Side (Ground Level Maintenance)

Hydraulic pump and engine filter compartment.



Engine Oil Filter



Pre-Filter with Integrated Water Separator



Fuel Filter

Note: AdBlue® is a registered trademark of the Verband der Automobilindustrie e.V. (VDA).

Specifications

Engine

Model	YANMAR 4TN107FTT
Type	Direct injection, water-cooled, 4-cycle diesel engine with turbocharger, intercooler, Tier IV Final certified
No. of cylinders	4
Bore and stroke	107 mm × 127 mm
Displacement	4.567 L
Rated power output	122 kW /2,000 min ⁻¹ (ISO 9249 : with fan)
	127 kW /2,000 min ⁻¹ (ISO 14396 : without fan)
Max. torque	791 N·m /1,500 min ⁻¹ (ISO 9249 : with fan)
	805 N·m/1,500 min ⁻¹ (ISO 14396 : without fan)

Hydraulic system

Pump	
Type	Axial piston pumps + extra gear pump + pilot gear pump
Max. discharge flow	2 × 220 L/min, 1 × 40.6 L/min, 1 × 20 L/min
Relief valve setting	
Boom, arm and bucket	34.3 MPa {350 kgf/cm ² }
Power Boost	37.8 MPa {385 kgf/cm ² }
Travel circuit	34.3 MPa {350 kgf/cm ² }
Swing circuit	SK225SR/SK230SRLC 29.0 MPa {296 kgf/cm ² }
	SK235SR/SK270SRLC 28.4 MPa {290 kgf/cm ² }
Control circuit	5.0 MPa {50 kgf/cm ² }
Pilot control pump	Gear type
Main control valve	8-spool
Oil cooler	Air cooled type

Swing system

Model	SK225SR/SK230SRLC	SK235SR/SK270SRLC
Swing motor	One fixed displacement piston motor	
Parking brake	Wet multiple plate	
Swing speed	12.6 min ⁻¹	10.2 min ⁻¹
Swing torque	73.0 kN·m	87.7 kN·m

Attachments

Backhoe bucket and combination

Use	Backhoe bucket					
	Normal digging					
Bucket capacity	ISO Heaped	m ³	0.51	0.7	0.8	0.93
	Struck	m ³	0.39	0.52	0.59	0.67
Opening width	With side cutters	mm	870	1,080	1,160	1,330
	Without side cutters	mm	770	980	1,060	1,230
No. of bucket teeth			3	5	5	5
Bucket weight		kg	520	630	660	710
Combinations	SK225SR/SK230SRLC 2.87 m standard arm		○	○	◎	△
	SK235SR/SK270SRLC 2.94 m standard arm		○	○	◎	△

◎ Standard ○ Recommended △ Loading only

Travel system

Model	SK225SR/SK230SRLC	SK235SR/SK270SRLC
Travel motors	2 × axial-piston, two-step motors	
Parking brakes	Wet multiple plate	
Travel shoes	46 each side (for SK225SR) 49 each side (for SK230SRLC)	47 each side (for SK235SR) 51 each side (for SK270SRLC)
Travel speed	5.8 / 3.5 km/h	5.2 / 3.2 km/h
Drawbar pulling force	227 kN (SAE)	244 kN (SAE)
Gradeability	70% {35°}	

Cab & control

Cab

All-weather, sound-suppressed steel cab mounted on the high suspension mounts filled with silicone oil and equipped with a heavy, insulated floor mat.

Control

Two hand levers and two foot pedals for travel

Two hand levers for excavating and swing

Electric rotary-type engine throttle

Boom, arm & bucket

bore × stroke

Model	SK225SR/SK230SRLC	SK235SR/SK270SRLC
Boom cylinders	120 mm × 1,355 mm	125 mm × 1,320 mm
Arm cylinder	130 mm × 1,406 mm	135 mm × 1,558 mm
Bucket cylinder	110 mm × 1,064 mm	120 mm × 1,080 mm

Dozer blade (Optional)

bore × stroke

Model	SK225SR	SK235SR
Dozer cylinder	140 mm × 200 mm	

Refilling capacities & lubrications

Model	SK225SR/SK230SRLC	SK235SR/SK270SRLC
Fuel tank	330 L	
Cooling system	23 L	
Engine oil	20 L	
Travel reduction gear	2 × 4.5 L	
Swing reduction gear	2.7 L	5.0 L
Hydraulic oil tank	114 L tank oil level	
	230 L hydraulic system	
DEF tank	33.9 L	

SK225SR SK230SR_{LC} SK235SR SK270SR_{LC}

SK225SR-7

SK230SR_{LC}-7

SK235SR-7

SK270SR_{LC}-7

Working ranges

Unit: mm

Model	SK225SR/SK230SR _{LC}	SK235SR/SK270SR _{LC}
Boom	5.62 m	5.65 m
Range	Standard 2.87 m	Standard 2.94 m
	Arm	
a- Max. digging reach	9,700	9,850
b- Max. digging reach at ground level	9,530	9,680
c- Max. digging depth	6,580	6,650
d- Max. digging height	10,580	11,210
e- Max. dumping clearance	7,710	8,330
f- Min. dumping clearance	2,980	3,140
g- Max. vertical wall digging depth	5,950	6,060
h- Min. swing radius	2,370	1,960
i- Horizontal digging stroke at ground level	5,030	5,270
j- Digging depth for 2.4 m (8') flat bottom	6,370	6,470
Bucket capacity ISO heaped m ³	0.80	0.80

Digging Force (ISO 6015)

Unit: kN

Model	SK225SR/SK230SR _{LC}	SK235SR/SK270SR _{LC}
Arm length	Standard 2.87 m	Standard 2.94 m
Bucket digging force	120 132*	143 157*
Arm crowding force	88.0 96.8*	102 112*

*Power Boost engaged.

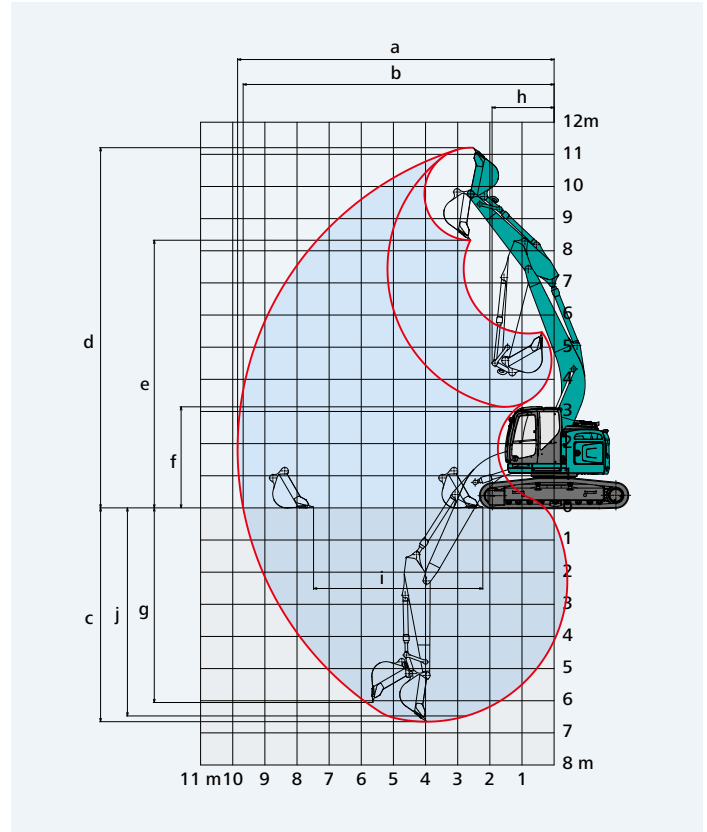

Dimensions

Unit: mm

Model	SK225SR	SK230SR _{LC}	SK235SR	SK270SR _{LC}
Boom	5.62 m		5.65 m	
Arm length	Standard 2.87 m		Standard 2.94 m	
A Overall length	8,690	8,830	8,780	8,970
A' Overall length (with dozer blade)	9,670	—	9,730	—
B Overall height (to top of boom)	3090		3,060	
C Overall width	2,800	2,990	2,990	3,190
D Overall height (to top of cab)	3,150		3,180	
E Ground clearance of rear end*	1,030		1,050	
F Ground clearance*	425		455	

G Tail swing radius (additional counterweight)	1,680 {1,850**}	1,720 {1,880**}		
G' Distance from centre of swing to rear end (additional counterweight)	1,680 {1,850**}	1,720 {1,880**}		
H Tumbler distance	3,370	3,660	3,470	3,850
I Overall length of crawler	4,170	4,450	4,260	4,640
J Track gauge	2,200	2,390	2,390	2,590
K Shoe width	600			
L Overall width of upperstructure	2,990			
M Dozer blade (up/down)	540/370	—	555/355	—

*Without including height of shoe lug

**Standard counterweight + additional counterweight 1,400 kg

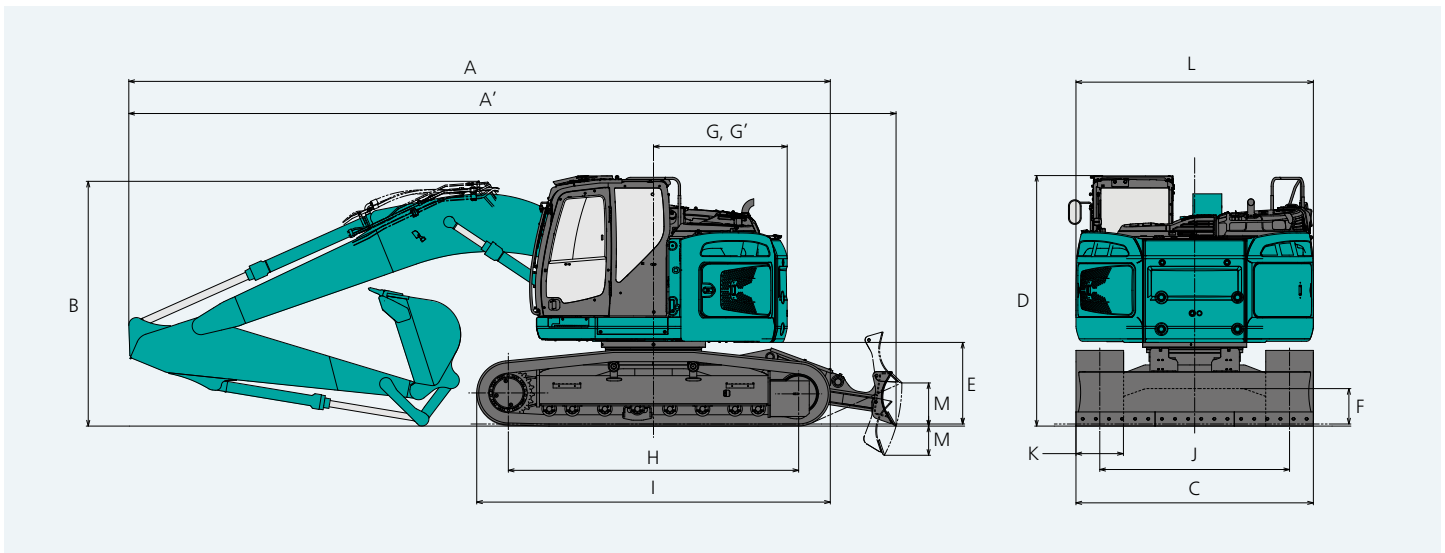

Operating weight & ground pressure

SK225SR/SK230SRLC

In standard trim, with standard boom, 2.87 m arm, and 0.8 m³ ISO heaped bucket, standard counterweight

Shaped			Triple grouser shoe			
Shoe width		mm	600	600 with DZ	700	790
Overall width of crawler	SK225SR	mm	2,800	2,800	2,900	2,990
	SK230SRLC	mm	2,990	—	3,090	3,180
Ground pressure	SK225SR	kPa	53	52	46	41
	SK230SRLC	kPa	50	—	43	39
Operation weight	SK225SR	kg	23,500	25,000	23,900	24,100
	SK230SRLC	kg	23,900	—	24,300	24,500

In standard trim, with standard boom, 2.87 m arm, and 0.8 m³ ISO heaped bucket, standard counterweight + additional counterweight 1,400 kg

Shaped			Triple grouser shoe			
Shoe width		mm	600	600 with DZ	700	790
Overall width of crawler	SK225SR	mm	2,800	2,800	2,900	2,990
	SK230SRLC	mm	2,990	—	3,090	3,180
Ground pressure	SK225SR	kPa	56	55	49	43
	SK230SRLC	kPa	53	—	46	41
Operation weight	SK225SR	kg	24,900	26,400	25,300	25,500
	SK230SRLC	kg	25,300	—	25,700	25,900

SK225SR
SK225SR-7

SK230SR_{LC}
SK230SR_{LC}-7

SK235SR
SK235SR-7

SK270SR_{LC}
SK270SR_{LC}-7

SK235SR/SK270SR_{LC}

In standard trim, with standard boom, 2.94 m arm, and 0.8 m³ ISO heaped bucket, standard counterweight

Shaped			Triple grouser shoe			
Shoe width		mm	600	600 with DZ	700	800
Overall width of crawler	SK235SR	mm	2,990	2,990	3,090	3,190
	SK270SR _{LC}	mm	3,190	—	3,290	3,390
Ground pressure	SK235SR	kPa	55	53	48	42
	SK270SR _{LC}	kPa	51	—	44	39
Operation weight	SK235SR	kg	25,200	26,800	25,500	25,800
	SK270SR _{LC}	kg	25,700	—	26,000	26,300

In standard trim, with standard boom, 2.94 m arm, and 0.8 m³ ISO heaped bucket, standard counterweight + additional counterweight 1,400 kg

Shaped			Triple grouser shoe			
Shoe width		mm	600	600 with DZ	700	800
Overall width of crawler	SK235SR	mm	2,990	2,990	3,090	3,190
	SK270SR _{LC}	mm	3,190	—	3,290	3,390
Ground pressure	SK235SR	kPa	58	56	50	45
	SK270SR _{LC}	kPa	54	—	47	41
Operation weight	SK235SR	kg	26,600	28,200	26,900	27,200
	SK270SR _{LC}	kg	27,100	—	27,400	27,700

Lift capacities

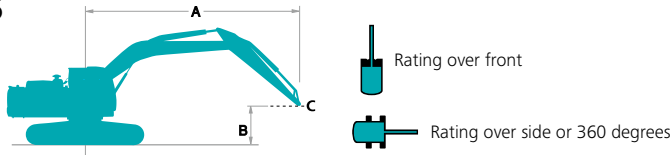

A - Reach from swing centerline to arm top
 B - Arm top height above/below ground
 C - Lift point
 Relief valve setting: 37.8 MPa (385 kgf/cm²)

SK225SR		Boom: 5.62 m Arm: 2.87 m Bucket: without Counterweight: 5,910 kg Shoe: 600 mm (Heavy Lift)														
B \ A		1.5 m		3.0 m		4.5 m		6.0 m		7.5 m		At max. reach		Radius		
9.0 m	kg													*3,920	*3,920	3.99 m
7.5 m	kg					*5,310	*5,310							*3,200	*3,200	5.97 m
6.0 m	kg					*5,790	*5,790	*5,330	4,450					*2,980	*2,980	7.11 m
4.5 m	kg			*9,230	*9,230	*7,750	6,730	*6,550	4,290	*4,250	2,980			*2,940	2,770	7.81 m
3.0 m	kg					*9,380	6,170	6,410	4,050	4,540	2,880			*3,030	2,500	8.18 m
1.5 m	kg					9,590	5,670	6,150	3,810	4,410	2,770			*3,250	2,400	8.25 m
G.L.	kg			*6,420	*6,420	9,280	5,410	5,960	3,640	4,320	2,680			*3,650	2,430	8.05 m
-1.5 m	kg	*6,660	*6,660	*10,550	10,120	9,190	5,330	5,890	3,580	4,300	2,670			4,270	2,650	7.55 m
-3.0 m	kg	*10,920	*10,920	*12,200	10,320	*9,140	5,410	5,940	3,620					5,130	3,170	6.67 m
-4.5 m	kg			*8,120	*8,120	*6,170	5,640							*4,950	4,580	5.24 m

SK225SR		Boom: 5.62 m Arm: 2.87 m Bucket: without Counterweight: 5,910 kg Shoe: 600 mm Dozer: blade up (Heavy Lift)														
B \ A		1.5 m		3.0 m		4.5 m		6.0 m		7.5 m		At max. reach		Radius		
9.0 m	kg													*3,920	*3,920	3.99 m
7.5 m	kg					*5,310	*5,310							*3,200	*3,200	5.97 m
6.0 m	kg					*5,790	*5,790	*5,330	4,730					*2,980	*2,980	7.11 m
4.5 m	kg			*9,230	*9,230	*7,750	7,140	*6,550	4,570	*4,250	3,200			*2,940	*2,940	7.81 m
3.0 m	kg					*9,380	6,580	6,530	4,330	4,630	3,100			*3,030	2,700	8.18 m
1.5 m	kg					9,780	6,090	6,270	4,090	4,500	2,980			*3,250	2,590	8.25 m
G.L.	kg			*6,420	*6,420	9,460	5,820	6,080	3,930	4,410	2,900			*3,650	2,630	8.05 m
-1.5 m	kg	*6,660	*6,660	*10,550	*10,550	9,380	5,750	6,010	3,860	4,390	2,890			4,350	2,860	7.55 m
-3.0 m	kg	*10,920	*10,920	*12,200	11,070	*9,140	5,820	6,060	3,910					5,230	3,420	6.67 m
-4.5 m	kg			*8,120	*8,120	*6,170	6,060							*4,950	4,920	5.24 m

SK225SR		Boom: 5.62 m Arm: 2.87 m Bucket: without Counterweight: 5,910 kg + 1,400 kg Shoe: 600 mm Dozer: blade up (Heavy Lift)														
B \ A		1.5 m		3.0 m		4.5 m		6.0 m		7.5 m		At max. reach		Radius		
9.0 m	kg													*3,920	*3,920	3.99 m
7.5 m	kg					*5,310	*5,310							*3,200	*3,200	5.97 m
6.0 m	kg					*5,790	*5,790	*5,330	*5,330					*2,980	*2,980	7.11 m
4.5 m	kg			*9,230	*9,230	*7,750	*7,750	*6,550	5,210	*4,250	3,680			*2,940	*2,940	7.81 m
3.0 m	kg					*9,380	7,500	*7,260	4,960	5,240	3,580			*3,030	*3,030	8.18 m
1.5 m	kg					*10,720	7,010	7,100	4,730	5,120	3,470			*3,250	3,020	8.25 m
G.L.	kg			*6,420	*6,420	10,740	6,740	6,910	4,560	5,030	3,380			*3,650	3,080	8.05 m
-1.5 m	kg	*6,660	*6,660	*10,550	*10,550	*10,600	6,670	6,840	4,490	*4,940	3,370			*4,390	3,340	7.55 m
-3.0 m	kg	*10,920	*10,920	*12,200	*12,200	*9,140	6,740	*6,770	4,540					*5,700	3,970	6.67 m
-4.5 m	kg			*8,120	*8,120	*6,170	*6,170							*4,950	*4,950	5.24 m

SK230SRLC		Boom: 5.62 m Arm: 2.87 m Bucket: without Counterweight: 5,910 kg Shoe: 600 mm (Heavy Lift)														
B \ A		1.5 m		3.0 m		4.5 m		6.0 m		7.5 m		At max. reach		Radius		
9.0 m	kg													*3,920	*3,920	3.99 m
7.5 m	kg					*5,310	*5,310							*3,200	*3,200	5.97 m
6.0 m	kg					*5,790	*5,790	*5,330	4,960					*2,980	*2,980	7.11 m
4.5 m	kg			*9,230	*9,230	*7,750	7,540	*6,550	4,800	*4,250	3,350			*2,940	*2,940	7.81 m
3.0 m	kg					*9,380	6,970	*7,260	4,550	5,170	3,250			*3,030	2,820	8.18 m
1.5 m	kg					*10,720	6,460	7,060	4,310	5,040	3,130			*3,250	2,720	8.25 m
G.L.	kg			*6,420	*6,420	10,870	6,180	6,870	4,140	4,950	3,050			*3,650	2,760	8.05 m
-1.5 m	kg	*6,660	*6,660	*10,550	*10,550	*10,600	6,110	6,790	4,070	4,930	3,030			*4,390	3,010	7.55 m
-3.0 m	kg	*10,920	*10,920	*12,200	12,050	*9,140	6,180	*6,770	4,120					*5,700	3,590	6.67 m
-4.5 m	kg			*8,120	*8,120	*6,170	*6,170							*4,950	*4,950	5.24 m

SK225SR

SK225SR-7

SK230SR_{LC}













SK230SR_{LC}-7













SK235SR













SK235SR-7













SK270SR_{LC}

SK270SR_{LC}-7

SK235SR		Boom: 5.65 m Arm: 2.94 m Bucket: without Counterweight: 5,910 kg Shoe: 600 mm (Heavy Lift)														
B	A	1.5 m		3.0 m		4.5 m		6.0 m		7.5 m		At max. reach		Radius		
																
9.0 m	kg													*5,200	*5,200	4.35 m
7.5 m	kg					*6,730	*6,730	*5,120	*5,120					*4,270	*4,270	6.20 m
6.0 m	kg					*7,000	*7,000	*6,350	5,130					*3,950	3,620	7.30 m
4.5 m	kg			*10,100	*10,100	*8,130	7,820	*6,790	4,940	5,070	3,410			*3,870	3,050	7.97 m
3.0 m	kg			*11,240	*11,240	*9,660	7,170	7,030	4,650	4,940	3,290			*3,940	2,760	8.32 m
1.5 m	kg					10,560	6,580	6,720	4,370	4,800	3,160			4,040	2,660	8.40 m
G.L.	kg			*6,640	*6,640	10,190	6,250	6,500	4,170	4,690	3,060			4,130	2,700	8.19 m
-1.5 m	kg	*6,750	*6,750	*11,340	*11,340	10,080	6,160	6,410	4,090	4,660	3,030			4,500	2,940	7.70 m
-3.0 m	kg	*11,820	*11,820	*11,260	*11,260	*8,610	6,240	*6,390	4,140					*5,030	3,500	6.84 m
-4.5 m	kg			*7,040	*7,040	*5,500	*5,500							*3,990	*3,990	5.45 m

SK235SR		Boom: 5.65 m Arm: 2.94 m Bucket: without Counterweight: 5,910 kg Shoe: 600 mm Dozer: blade up (Heavy Lift)														
B	A	1.5 m		3.0 m		4.5 m		6.0 m		7.5 m		At max. reach		Radius		
																
9.0 m	kg													*5,200	*5,200	4.35 m
7.5 m	kg					*6,730	*6,730	*5,120	*5,120					*4,270	*4,270	6.20 m
6.0 m	kg					*7,000	*7,000	*6,350	5,450					*3,950	3,870	7.30 m
4.5 m	kg			*10,100	*10,100	*8,130	*8,130	*6,790	5,250	5,150	3,650			*3,870	3,280	7.97 m
3.0 m	kg			*11,240	*11,240	*9,660	7,630	7,140	4,970	5,020	3,530			*3,940	2,980	8.32 m
1.5 m	kg					10,730	7,040	6,820	4,690	4,870	3,400			4,110	2,870	8.40 m
G.L.	kg			*6,640	*6,640	10,350	6,720	6,600	4,490	4,770	3,300			4,200	2,920	8.19 m
-1.5 m	kg	*6,750	*6,750	*11,340	*11,340	10,240	6,630	6,510	4,410	4,740	3,270			4,580	3,170	7.70 m
-3.0 m	kg	*11,820	*11,820	*11,260	*11,260	*8,610	6,700	*6,390	4,460					*5,030	3,770	6.84 m
-4.5 m	kg			*7,040	*7,040	*5,500	*5,500							*3,990	*3,990	5.45 m

SK235SR		Boom: 5.65 m Arm: 2.94 m Bucket: without Counterweight: 5,910 kg + 1,400 kg Shoe: 600 mm Dozer: blade up (Heavy Lift)														
B	A	1.5 m		3.0 m		4.5 m		6.0 m		7.5 m		At max. reach		Radius		
																
9.0 m	kg													*5,200	*5,200	4.35 m
7.5 m	kg					*6,730	*6,730	*5,120	*5,120					*4,270	*4,270	6.20 m
6.0 m	kg					*7,000	*7,000	*6,350	6,120					*3,950	*3,950	7.30 m
4.5 m	kg			*10,100	*10,100	*8,130	*8,130	*6,790	5,930	5,790	4,170			*3,870	3,750	7.97 m
3.0 m	kg			*11,240	*11,240	*9,660	8,620	*7,440	5,640	5,660	4,050			*3,940	3,430	8.32 m
1.5 m	kg					*10,820	8,030	7,690	5,360	5,510	3,910			*4,170	3,310	8.40 m
G.L.	kg			*6,640	*6,640	*11,020	7,710	7,470	5,170	5,400	3,810			*4,610	3,380	8.19 m
-1.5 m	kg	*6,750	*6,750	*11,340	*11,340	*10,280	7,620	7,370	5,080	5,380	3,790			5,190	3,660	7.70 m
-3.0 m	kg	*11,820	*11,820	*11,260	*11,260	*8,610	7,690	*6,390	5,130					*5,030	4,340	6.84 m
-4.5 m	kg			*7,040	*7,040	*5,500	*5,500							*3,990	*3,990	5.45 m

SK270SR _{LC}		Boom: 5.65 m Arm: 2.94 m Bucket: without Counterweight: 5,910 kg Shoe: 600 mm (Heavy Lift)														
B	A	1.5 m		3.0 m		4.5 m		6.0 m		7.5 m		At max. reach		Radius		
																
9.0 m	kg													*5,200	*5,200	4.35 m
7.5 m	kg					*6,730	*6,730	*5,120	*5,120					*4,270	*4,270	6.20 m
6.0 m	kg					*7,000	*7,000	*6,350	5,770					*3,950	*3,950	7.30 m
4.5 m	kg			*10,100	*10,100	*8,130	*8,130	*6,790	5,570	6,000	3,870			*3,870	3,470	7.97 m
3.0 m	kg			*11,240	*11,240	*9,660	8,180	*7,440	5,280	5,870	3,740			*3,940	3,150	8.32 m
1.5 m	kg					*10,820	7,570	*7,990	4,990	5,710	3,610			*4,170	3,040	8.40 m
G.L.	kg			*6,640	*6,640	*11,020	7,240	7,830	4,790	5,600	3,500			*4,610	3,100	8.19 m
-1.5 m	kg	*6,750	*6,750	*11,340	*11,340	*10,280	7,140	*7,700	4,710	5,580	3,480			5,380	3,370	7.70 m
-3.0 m	kg	*11,820	*11,820	*11,260	*11,260	*8,610	7,220	*6,390	4,760					*5,030	4,010	6.84 m
-4.5 m	kg			*7,040	*7,040	*5,500	*5,500							*3,990	*3,990	5.45 m

- Note:**
- Do not attempt to lift or hold any load that is greater than these lift capacities at their specified lift point radius and heights. Weight of all accessories must be deducted from the above lift capacities.
 - Lift capacities are based on machine standing on level, firm, and uniform ground. User must make allowance for job conditions such as soft or uneven ground, out of level conditions, side loads, sudden stopping of loads, hazardous conditions, experience of personnel, etc.
 - Bucket pin attachment point defined as lift point.
 - The above lift capacities are in compliance with ISO 10567. They do not exceed 87% of hydraulic lift capacity or 75% of tipping load. Lift capacities marked with an asterisk (*) are limited by hydraulic capacity rather than tipping load.
 - Operator should be fully acquainted with the Operator's and Maintenance Instructions before operating this machine. Rules for safe operation of equipment should be adhered to at all times.
 - Lift capacities apply to only machine as originally manufactured and normally equipped by KOBELCO CONSTRUCTION MACHINERY CO., LTD.

Standard and Optional Equipment

●=Std ○=Opt — = N/A

Category	Description	SK225SR-7	SK230SR _{LC} -7	SK235SR-7	SK270SR _{LC} -7
Engine	YANMAR 4TN107FTT (Tier IV Final certified)	●	●	●	●
	Exhaust DOC DPF SCR system	●	●	●	●
	Alternator 24 V /80 A	●	●	●	●
	Starter motor 24 V/5 kW	●	●	●	●
	Batteries 2x 12V (105Ah)	●	●	●	●
	Fan suction type cooling system	●	●	●	●
	iNDR system	●	●	●	●
	Auto deceleration function	●	●	●	●
	Auto idle stop	●	●	●	●
Hydraulic system	3 work modes H, S, Eco	●	●	●	●
	Power boost (37.8 MPa {385 kgf/cm ² })	●	●	●	●
	Heavy lift mode	●	●	●	●
	Pressure release function	●	●	●	●
	Independent travel function	●	●	●	●
	Auto warm up system	●	●	●	●
	Proportional Hand Control (for E&N&B piping)	●	●	●	●
	Hydraulic oil VG46	●	●	●	●
	Piping	E & N&B piping	●	●	●
QH piping		●	●	●	●
Cabin	Air suspension seat with heating	●	●	●	●
	10 inch colour monitor	●	●	●	●
	LED door light	●	●	●	●
	Air-conditioner	●	●	●	●
	Radio (FM/AM & AUX & USB & Bluetooth® & hands free telephone)	●	●	●	●
	Harness for cab four lights and cab yellow flasher	●	●	●	●
	Intermittent windshield wiper	●	●	●	●
	12V power outlet	●	●	●	●
	Rain visor	○	○	○	○
Lights	LED work lights ; 2 on boom, 1 on upper frame, 2 on rear counterweight	●	●	●	●
	LED work lights ; 2 on cab top front	○	○	○	○
Working equipment	Standard boom (5.62m)	●	●	—	—
	Standard boom (5.65m)	—	—	●	●
	Standard arm (2.87m)	●	●	—	—
	Standard HD arm (2.94m) with rock guard	—	—	●	●
Counter weight	Standard CW (5,910kg)	●	●	●	●
	Standard CW (5,910kg) + Additional CW (1,400kg)	○	○	○	○
Undercarriage	600mm steel shoe	●	●	●	●
	700mm steel shoe	○	○	○	○
	790mm steel shoe	○	○	—	—
	800mm steel shoe	—	—	○	○
	Track guide (one per side)	●	●	●	●
	Additional track guides (two additional per side)	○	○	○	○
	Lower frame guard	●	●	●	●
	Dozer blade (2,800mm) for 600mm shoe	○	—	○	—
	Dozer blade (2,990mm) for 600mm shoe	○	—	○	—
Safety	Engine emergency stop switch	●	●	●	●
	Pump emergency mode (KPSS release switch)	●	●	●	●
	Emergency accel dial	●	●	●	●
	Emergency manual valve for lowering attachment	●	●	●	●
	Safety valve for boom & arm cylinder	●	●	●	●
	ROPS compliant cab (ISO 12117-2:2008)	●	●	●	●
	OPG Level II top guard (ISO 10262;1998)	●	●	●	●
	OPG Level II front guard (ISO 10262;1998)	○	○	○	○
	Eagle-eye view camera (Rear, Right, Left)	●	●	●	●
	Seatbelt indicator on display	●	●	●	●
	Travel alarm	●	●	●	●
Others	Refueling pump	○	○	○	○
	Harness for engine room light	●	●	●	●
	RAL color	○	○	○	○
	GEOSCAN	●	●	●	●

*The air conditioning system on this machine contains fluorinated greenhouse gas HFC-134a (GWP 1430). Quantity of gas 0.8 kg (CO2 equivalent 1.2 t).
 Note: Bluetooth® is a registered trademark of the Bluetooth SIG Inc.

Note: This catalogue may contain attachments and optional equipment that are not available in your area. And it may contain photographs of machines with specifications that differ from those of machines sold in your areas. Please consult your nearest KOBELCO distributor for those items you require.
 Specialist equipment is needed to use this machine in demolition work. Before using it please contact your KOBELCO dealer.
 Due to our policy of continuous product improvements all designs and specifications are subject to change without advance notice.
 Copyright by **KOBELCO CONSTRUCTION MACHINERY CO., LTD.** No part of this catalogue may be reproduced in any manner without notice.

KOBELCO CONSTRUCTION MACHINERY CO., LTD.

5-15, Kitashinagawa 5-chome, Shinagawa-ku, Tokyo 141-8626 JAPAN
 Tel: +81 (0) 3-5789-2146 Fax: +81 (0) 3-5789-2135
 www.kobelcocm-global.com

Enquiries To: